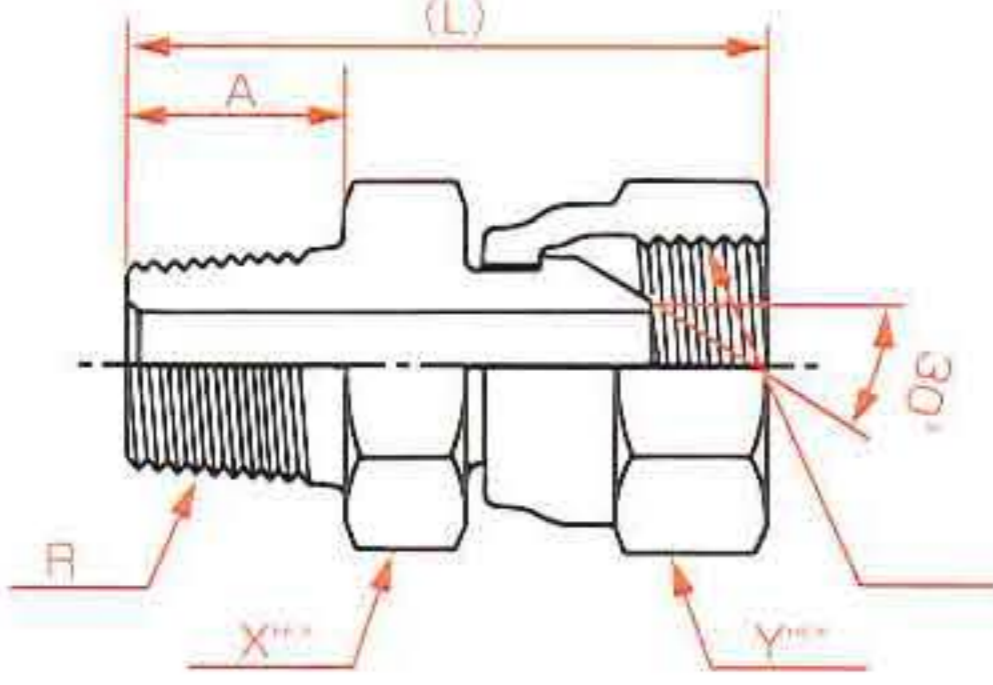
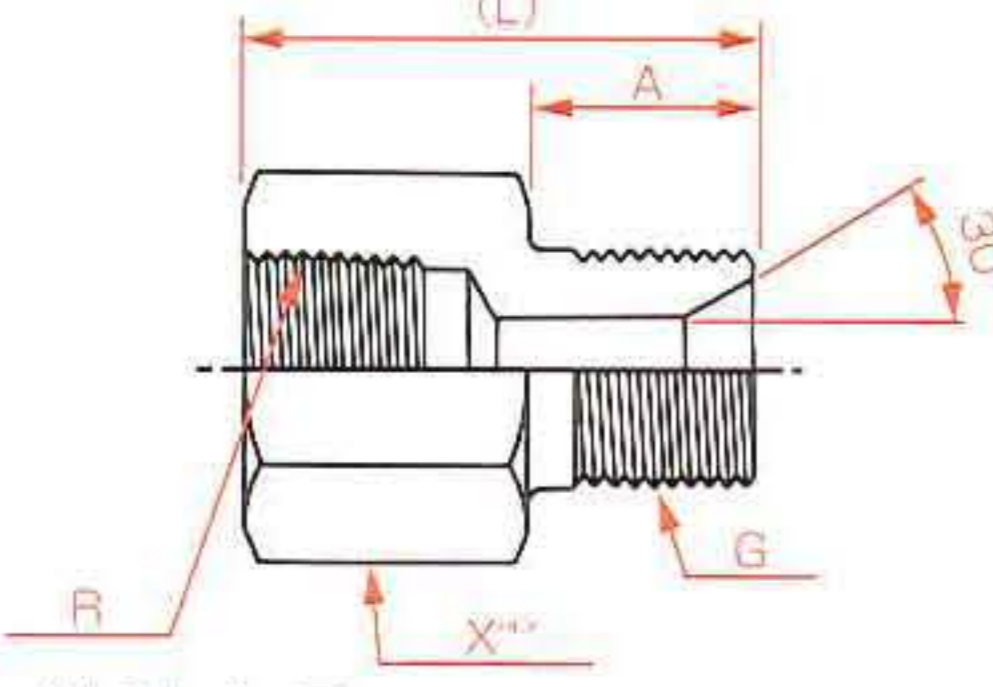
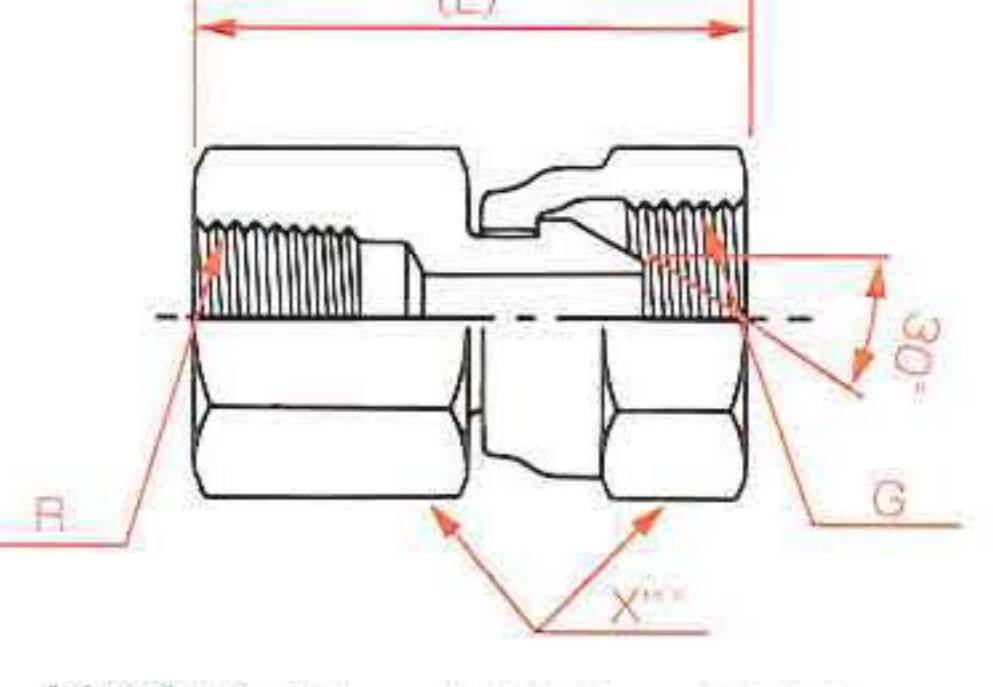
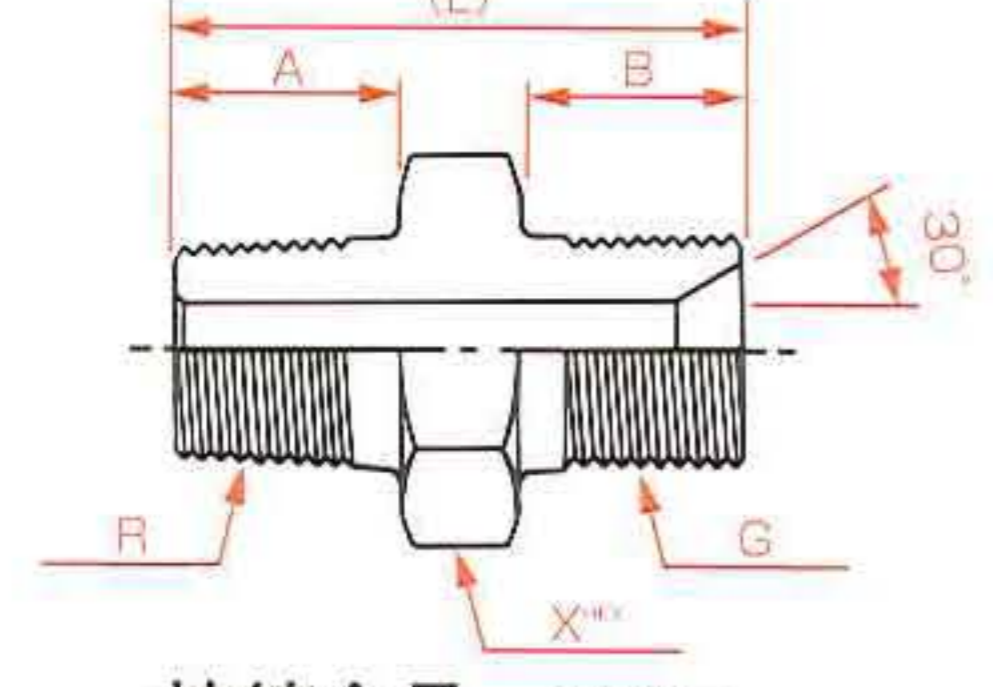

付属品

アダプターの種類

IV 付属品

アダプターの種類

形状	アダプター番	ねじ R(PT) G(PF)	内径 mm	A mm	B mm	(L) mm	X mm	Y mm	概略 重量 g
 <p>接続金具 1002</p>	1006 6	1/4	5.0	13	-	39	17	19	55
	1006 9	3/8	8.0	15	-	43	19	22	70
	1006 12	1/2	11.0	18	-	49	22	27	115
	1006 19	3/4	16.0	20	-	56	30	36	240
	1006 25	1	22.0	22	-	61	36	41	305
	1006 32	1 1/4	27.5	25	-	70	46	50	540
	1006 38	1 1/2	34.0	25	-	73	50	60	710
	1006 50	2	46.0	29	-	84	65	70	1080
 <p>接続金具 1001, 1005</p>	1007 6	1/4	5.0	13	-	30	19	-	35
	1007 9	3/8	8.0	15	-	34	22	-	55
	1007 12	1/2	11.0	18	-	40	27	-	95
	1007 19	3/4	16.0	20	-	45	36	-	175
	1007 25	1	22.0	22	-	49	41	-	220
	1007 32	1 1/4	27.5	25	-	55	50	-	350
	1007 38	1 1/2	34.0	25	-	55	60	-	470
 <p>接続金具 1001, 1002</p>	1008 6	1/4	5.0	-	-	35	19	-	55
	1008 9	3/8	8.0	-	-	39	22	-	75
	1008 12	1/2	11.0	-	-	44	27	-	120
	1008 19	3/4	16.0	-	-	49	36	-	260
	1008 25	1	22.0	-	-	53	41	-	330
	1008 32	1 1/4	27.5	-	-	62	50	-	420
	1008 38	1 1/2	34.0	-	-	64	60	-	680
 <p>接続金具 1005</p>	1009 6	1/4	5.0	13	13	34	17	-	40
	1009 9	3/8	8.0	15	15	38	19	-	60
	1009 12	1/2	11.0	18	18	46	22	-	100
	1009 19	3/4	16.0	20	20	52	30	-	170
	1009 25	1	22.0	22	22	56	36	-	255
	1009 32	1 1/4	27.5	25	25	64	46	-	460
1009 38	1 1/2	34.0	25	25	65	50	-	520	
1009 50	2	46.0	29	29	76	65	-	860	

アダプターの種類

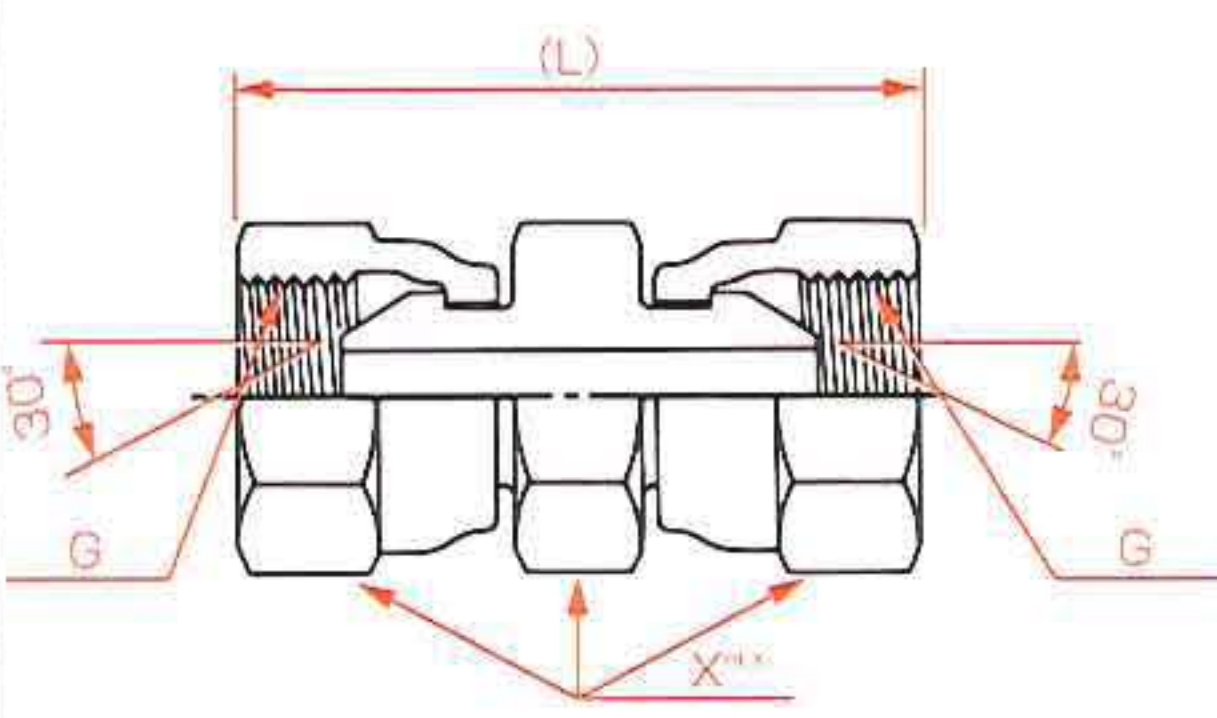
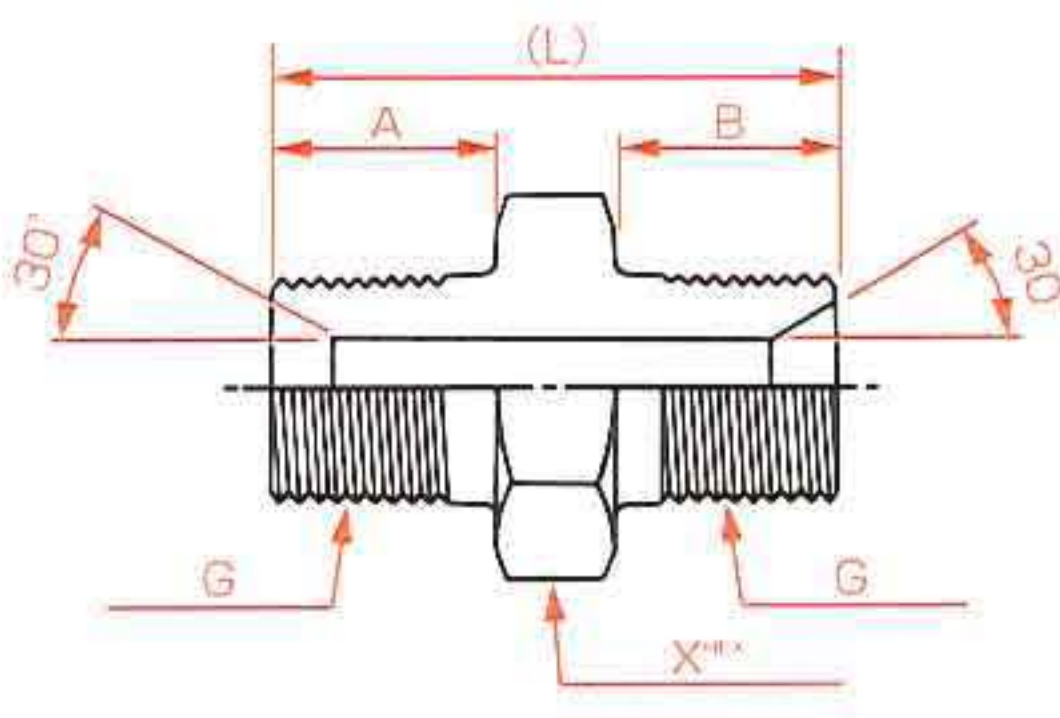
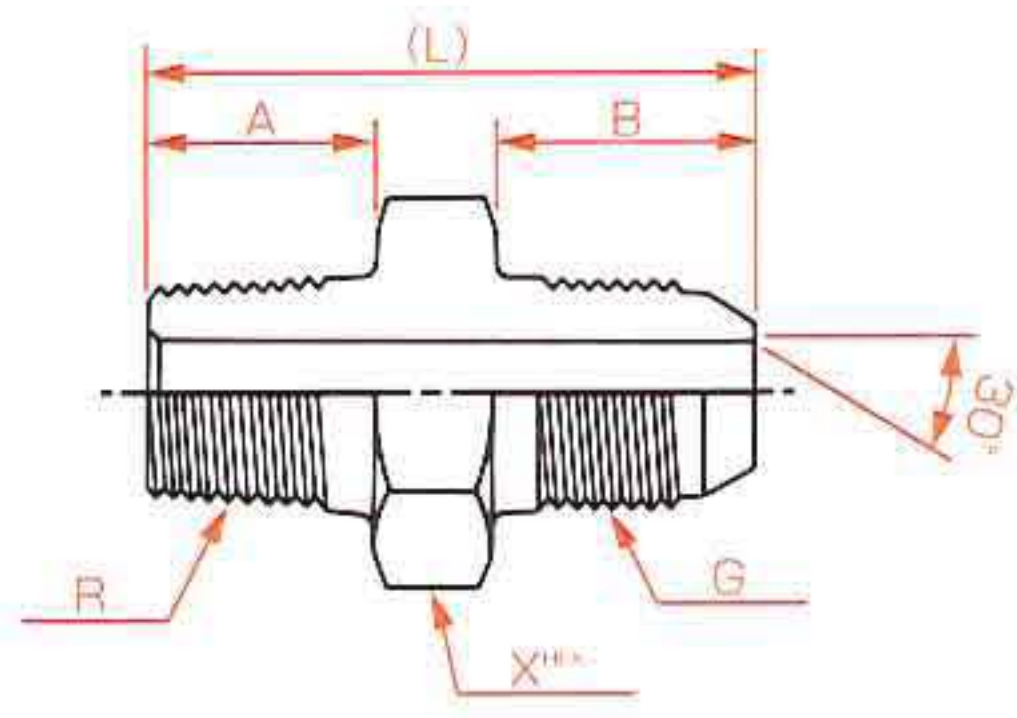
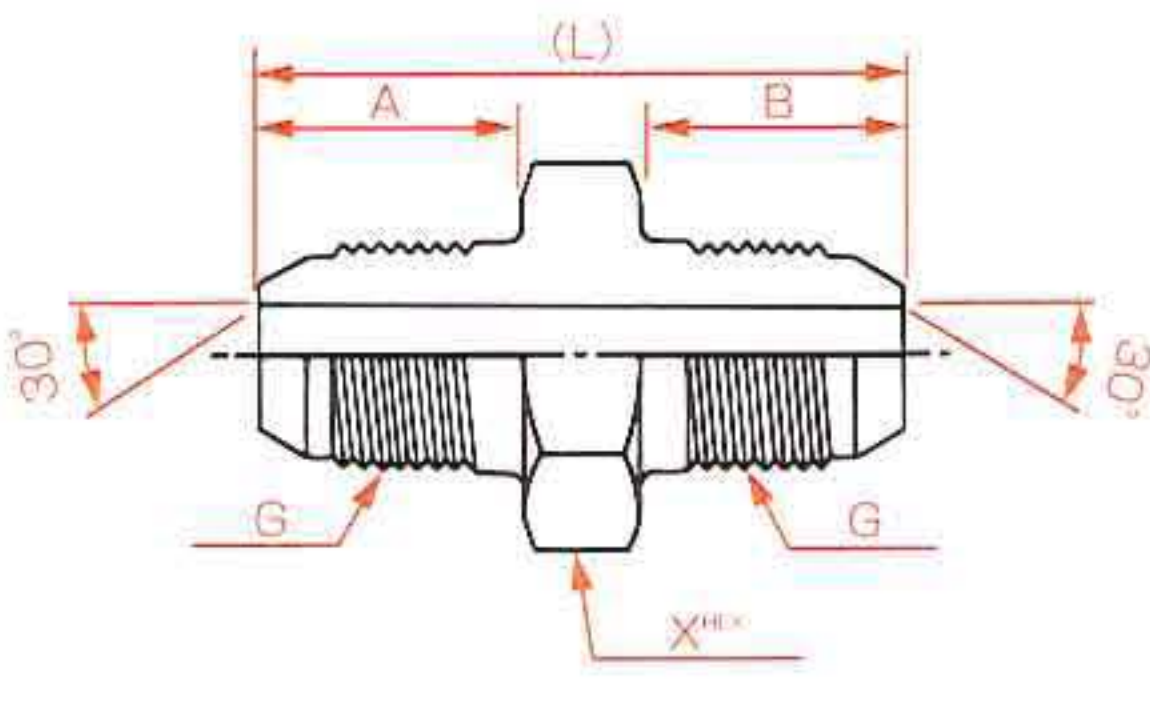
形状	アダプター 品番	ねじ R(PT) G(PF)	内径 mm	A mm	B mm	(L) mm	X mm	概略 重量 g
<p>1010 めすーめすユニオン</p>  <p>接続金具 1002</p>	1010 6	1/4	5.0	-	-	44	17	70
	1010 9	3/8	8.0	-	-	48	19	80
	1010 12	1/2	11.0	-	-	54	22	140
	1010 19	3/4	16.0	-	-	61	30	300
	1010 25	1	22.0	-	-	65	36	350
	1010 32	1 1/4	27.5	-	-	78	46	625
	1010 38	1 1/2	34.0	-	-	82	50	900
	1010 50	2	46.0	-	-	93	65	1310
<p>1011 おすーおす</p>  <p>接続金具 1005</p>	1011 6	1/4	5.0	13	13	34	17	40
	1011 9	3/8	8.0	15	15	38	19	55
	1011 12	1/2	11.0	18	18	46	22	95
	1011 19	3/4	16.0	20	20	52	30	170
	1011 25	1	22.0	22	22	56	36	250
	1011 32	1 1/4	27.5	25	25	64	46	455
	1011 38	1 1/2	34.0	25	25	65	50	510
	1011 50	2	46.0	29	29	76	65	855
<p>1013 おすーおす</p>  <p>接続金具 1004</p>	1013 6	1/4	5.0	13	16	37	17	40
	1013 9	3/8	8.0	15	18	41	19	60
	1013 12	1/2	11.0	18	20	48	22	100
	1013 19	3/4	16.0	20	22	54	30	175
	1013 25	1	22.0	22	24	58	36	255
	1013 32	1 1/4	27.5	25	27	66	46	470
	1013 38	1 1/2	34.0	25	27	67	50	530
	1013 50	2	46.0	29	30	77	65	860
<p>1014 おすーおす</p>  <p>接続金具 1004</p>	1014 6	1/4	5.0	16	16	40	17	40
	1014 9	3/8	8.0	18	18	44	19	60
	1014 12	1/2	11.0	20	20	50	22	95
	1014 19	3/4	16.0	22	22	56	30	170
	1014 25	1	22.0	24	24	60	36	250
	1014 32	1 1/4	27.5	27	27	68	46	460
	1014 38	1 1/2	34.0	27	27	69	50	520
	1014 50	2	46.0	30	30	78	65	830

アダプターの種類

形状	アダプター 品番	ねじ R(PT) G(PF)	内径 mm	A mm	B mm	C mm	E mm	W mm	概略 重量 g	
	1033	6	1/4	5.0	17	16	26	25	17	60
	1033	9	3/8	8.0	20	18	30	28	19	100
	1033	12	1/2	11.0	24	20	36	32	24	175
	1033	19	3/4	16.0	28	22	43	37	30	295
	1033	25	1	22.0	32	24	50	42	36	470
	1033	32	1 1/4	27.5	35	27	58	50	46	940
	1033	38	1 1/2	34.0	38	27	63	52	50	960
	1033	50	2	46.0	42	30	75	63	65	1560
接続金具 1004										
	1034	6	1/4	5.0	17	13	26	22	17	60
	1034	9	3/8	8.0	20	15	30	25	19	100
	1034	12	1/2	11.0	24	18	36	30	24	180
	1034	19	3/4	16.0	28	20	43	35	30	280
	1034	25	1	22.0	32	22	50	40	36	480
	1034	32	1 1/4	27.5	35	25	58	48	46	910
	1034	38	1 1/2	34.0	38	25	63	50	50	1020
	1034	50	2	46.0	42	29	75	62	65	1810
接続金具 1005										
	1035	6	1/4	5.0	13	16	19	22	17	45
	1035	9	3/8	8.0	15	18	22	25	19	75
	1035	12	1/2	11.0	18	20	26	28	24	125
	1035	19	3/4	16.0	20	22	30	32	30	210
	1035	25	1	22.0	22	24	34	36	36	330
	1035	32	1 1/4	27.5	25	27	40	42	46	645
	1035	38	1 1/2	34.0	25	27	41	43	50	735
	1035	50	2	46.0	29	30	50	51	65	1340
接続金具 1004										
	1036	6	1/4	5.0	13	13	19	19	17	45
	1036	9	3/8	8.0	15	15	22	22	19	75
	1036	12	1/2	11.0	18	18	26	26	24	130
	1036	19	3/4	16.0	20	20	30	30	30	210
	1036	25	1	22.0	22	22	34	34	36	330
	1036	32	1 1/4	27.5	25	25	40	40	46	560
	1036	38	1 1/2	34.0	25	25	41	41	50	835
	1036	50	2	46.0	29	29	50	51	65	1095
接続金具 1005										

1 アダプター(WS18ホース用)

WS18ホース用(材質:ブラス)

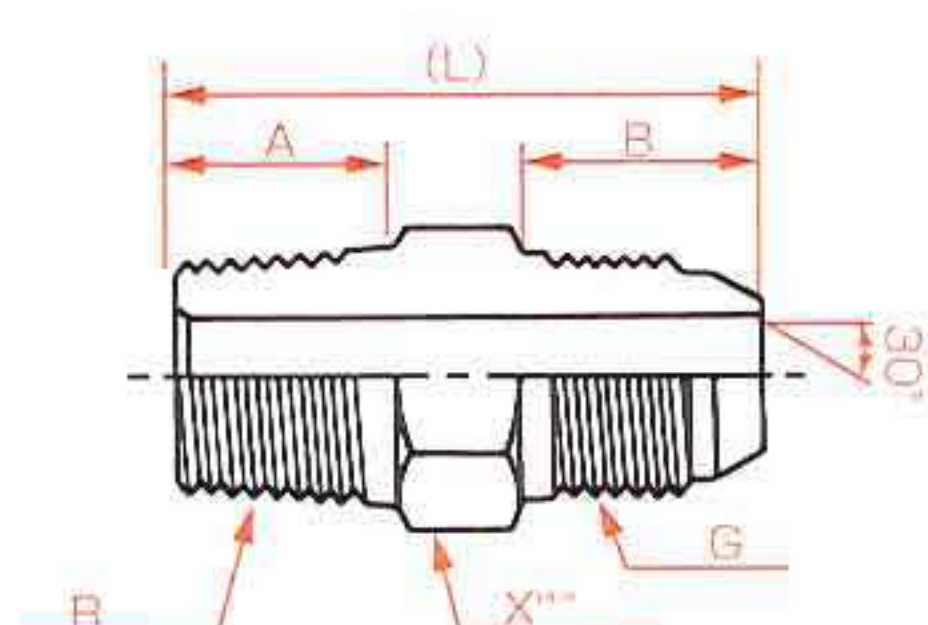
形状	アダプター 品番	ねじ R(PT)	ねじ G(PF)	内径 mm	A mm	B mm	(L) mm	X mm	概略 重量 g
	3013 -04B	1/4	1/4	5	13	16	34	14	30
	3013-0204B	1/8	1/4	5	10	16	31	14	25
	3013 -06B	3/8	3/8	7	14	17.5	39	17	50
	3013-0406B	1/4	3/8	7	13	17.5	36	17	45
	3013 -08B	1/2	1/2	10	18	20	48	22	100
	3013 -12B	3/4	3/4	16	20	21.5	54	30	160

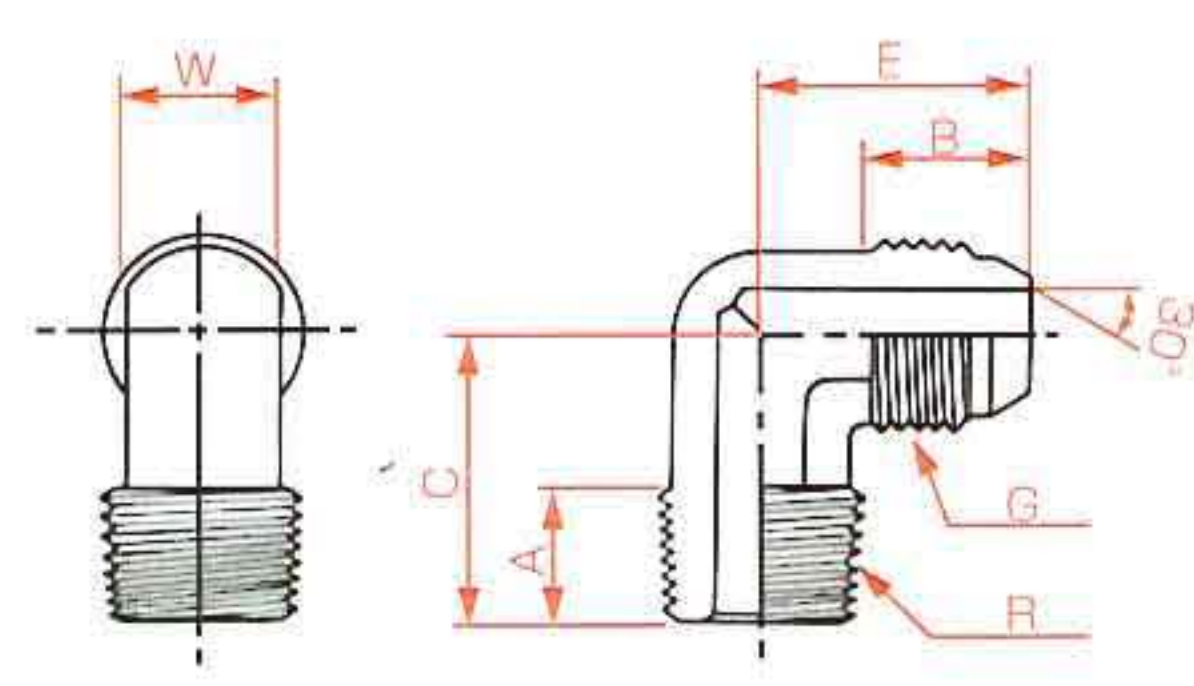
アダプター 品番	ねじ R(PT) G(PF)	内径 mm	A mm	B mm	C mm	E mm	W mm	概略 重量 g	
	3033 -04B	1/4	5	11	13	23	24	12	40
	3033 -06B	3/8	7	12	14	27	26	14	65
	3033 -08B	1/2	10	15	17	32	31	17	110

● スプリットフランジ用クランプハーフ・JIS相フランジ

形状		品番	フランジ インチ サイズ	D mm	F mm	J mm	P mm	Q mm	R mm	T mm	U mm	概略 重量 g
<p>SCLH SAEスタンダード プレッシャー用</p>		SCLH 12	1/2	31.0	6.2	24.3	21.8	38.1	8	8.7	13	65
		SCLH 19	3/4	38.9	6.2	32.1	24.9	47.6	10	10.3	14	110
		SCLH 25	1	45.2	7.5	38.9	28.2	52.4	12	10.3	16	120
		SCLH 32	1-1/4	51.6	7.5	43.7	35.3	58.7	14	11.9	14	160
		SCLH 38	1-1/2	61.1	7.5	51.2	40.1	69.9	17	13.5	19 (16)	290
		SCLH 50	2	72.2	9.0	63.1	48.0	77.8	21	13.5	19 (16)	370
<p>HCLH SAE ハイプレッシャー用</p>		HCLH 12	1/2	32.5	7.2	24.6	22.6	40.5	8	8.7	16	80
		HCLH 19	3/4	42.1	8.3	32.5	29.0	50.8	11	10.3	19	185
		HCLH 25	1	48.4	9.0	38.9	33.8	57.2	13	11.9	24	290
		HCLH 32	1-1/4	54.8	9.9	44.5	38.6	66.7	15	13.5	27	380
		HCLH 38	1-1/2	64.3	12.2	51.6	46.5	79.4	17	16.7	30	640
		HCLH 50	2	80.2	12.1	67.6	55.9	96.8	21	19.8	37	1130
<p>SHB JIS21MPa 相フランジ</p>		品番	JIS 大きさの呼び	A mm	B mm	C mm	d mm	d ₂ mm	d ₄ mm	概略 重量 g		
		SHB 12	15	63	40	22	16.0	22.2	11	590		
		SHB 19	20	68	45	22	20.0	27.7	11	650		
		SHB 25	25	80	53	28	25.0	34.5	13	1130		
		SHB 32	32	90	63	28	31.5	43.2	13	1350		
		SHB 38	40	100	70	35	37.5	49.1	18	2050		
		SHB 50	50	112	80	35	47.5	61.1	18	2300		

スプリットフランジ用Oリング

スタンダード ハイプレッシャー用
硬度：90°

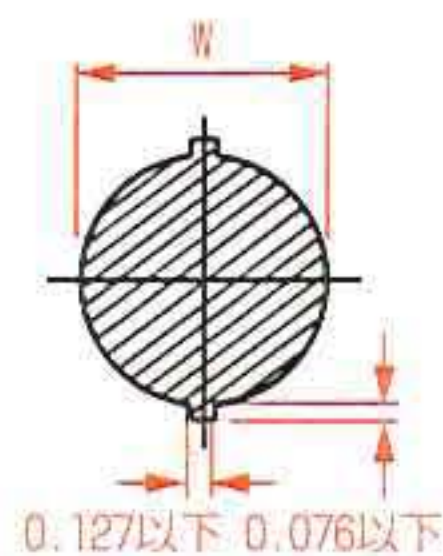
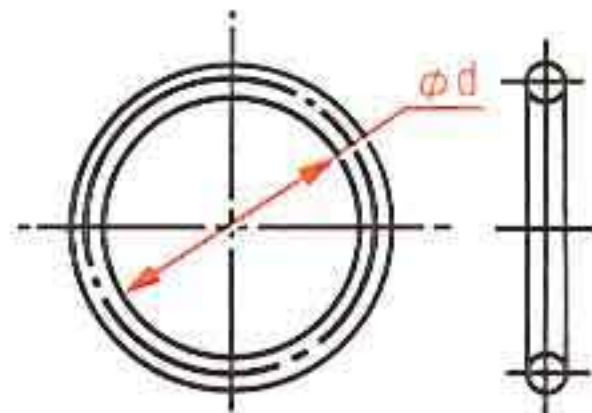

サイズ	品番	SAE MIL-9-25732	d mm	W mm
-08	AS568-210-1B	210	18.64±0.15	3.53±0.1
-12	AS568-214-1B	214	24.99±0.15	3.53±0.1
-16	AS568-219-1B	219	32.92±0.15	3.53±0.1
-20	AS568-222-1B	222	37.69±0.15	3.53±0.1
-24	AS568-225-1B	225	47.22±0.25	3.53±0.1
-32	AS568-228-1B	228	56.74±0.25	3.53±0.1

JIS21MPa
SHA・SSA用Oリング

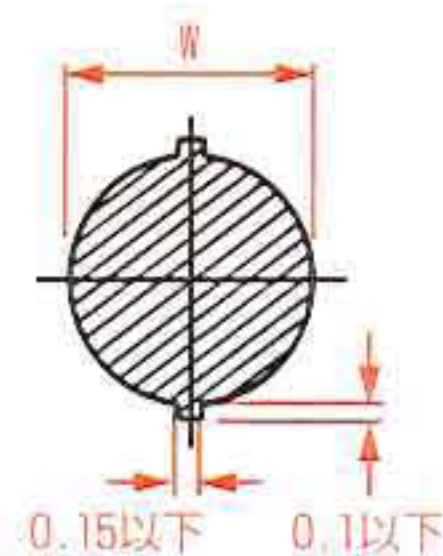
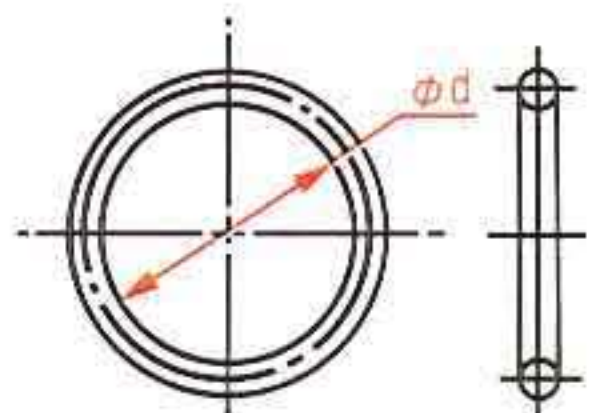

サイズ	品番	JIS B2401	d mm	W mm
12	G251B	G25	24.4±0.15	3.1±0.1
19	G301B	G30	29.4±0.15	3.1±0.1
25	G351B	G35	34.4±0.15	3.1±0.1
32	G401B	G40	39.4±0.15	3.1±0.1
38	G501B	G50	49.4±0.25	3.1±0.1
50	G601B	G60	59.4±0.25	3.1±0.1

※ボルト、ナット、ワッシャーも準備しています。